

FSS pokrywa silnika
7101501600

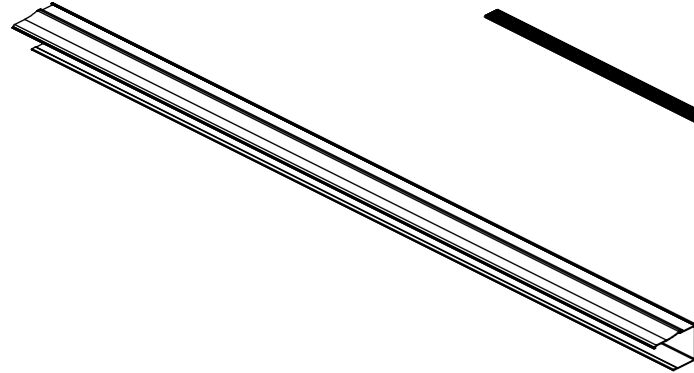

FSS rzep twardy 20 mm 1,2m
3416500004

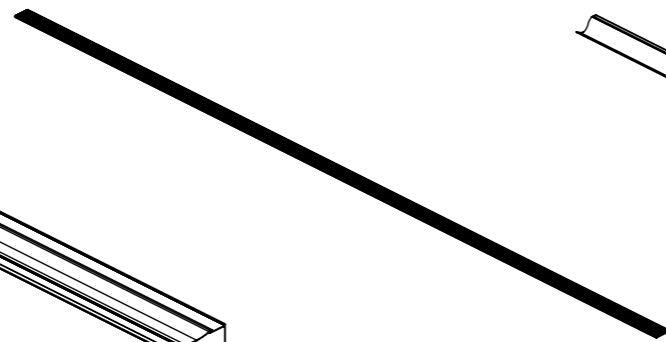

FSS pokrywa płaska nap du
7101501620

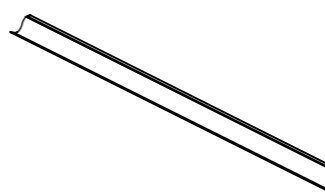

FSS szyna poprzeczna mts, dł 580 cm
7101001580

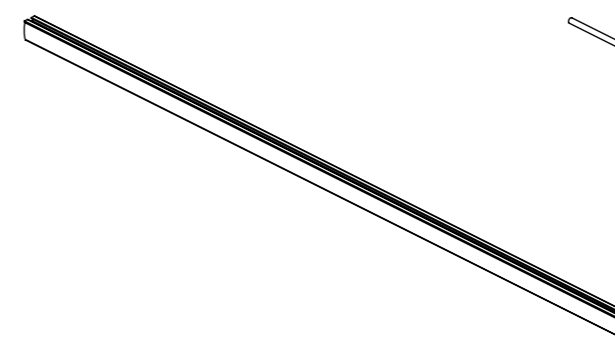

FSS pr t/rurka aluminium 8 mm, L= 6m
7135301600

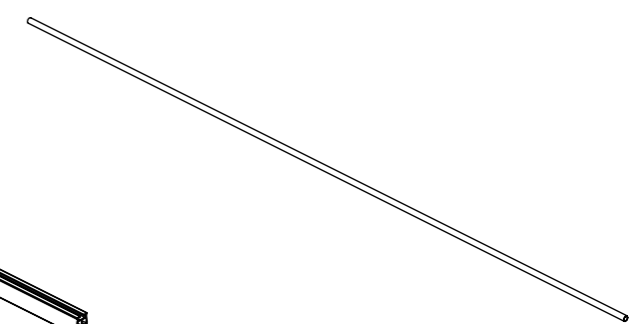

FSS przyrz d monta owy
7150000001

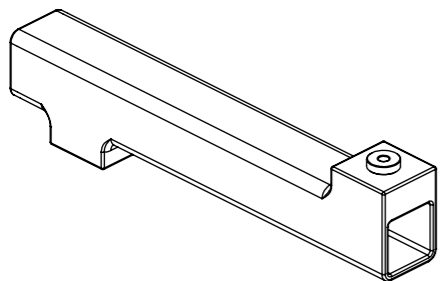

FSS wałek pr ta nap dowego
7103011000

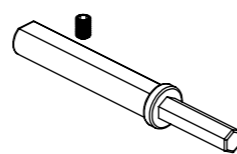

FSS pokrywa nap du
7101501610

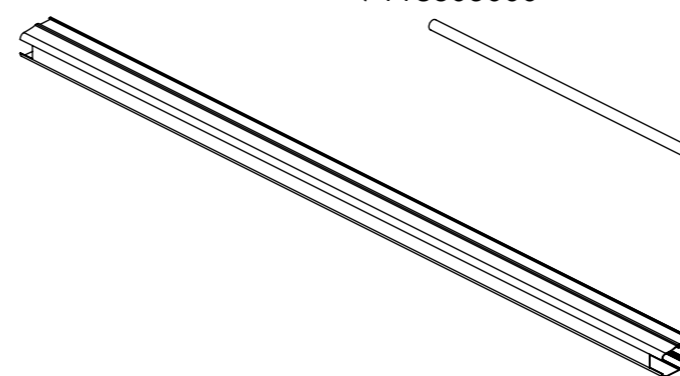

FSS pr t 15 mm
7118305000

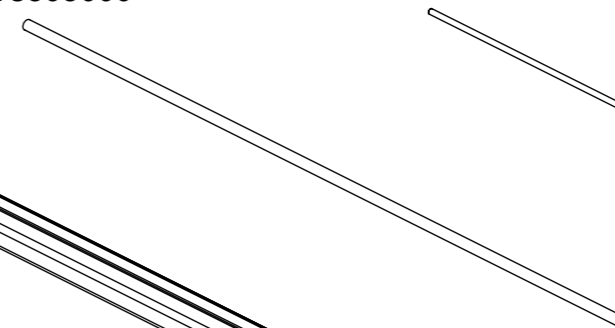

FSS pr t 8 mm włókno szklane
7135401600

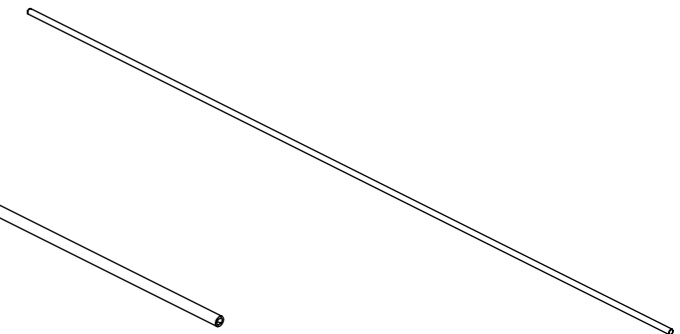

FSS suwak spr ynowy
7110001000

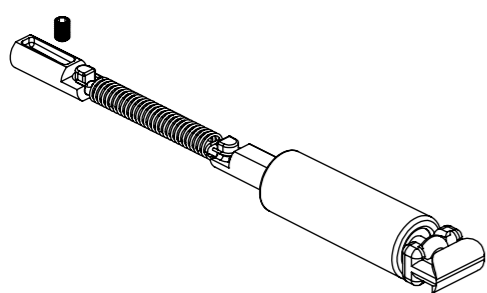

FSS blokada ramion prowadz cych
7116401000

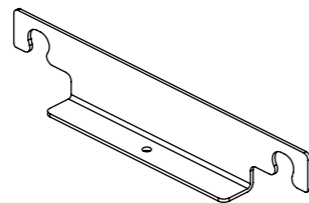

FSS suwak heavy-duty
7140000000

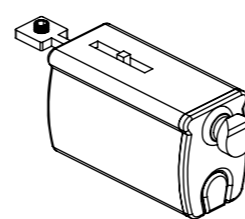

FSS Shuttle slave
7131000000

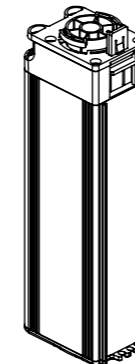

FSS zasilanie - komplet
5201002002

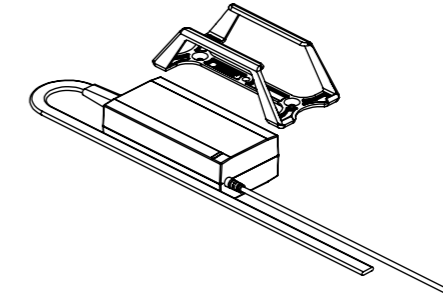

FSS kabel tandem
7113000000

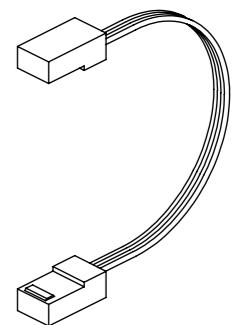

FSS suwak spr ynowy
z uchwytem pr tów 8 mm
7130000000

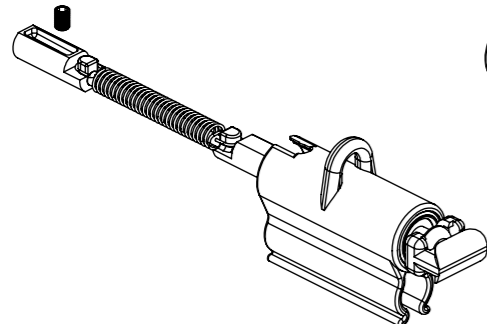

FSS uchwyt pr tów 8 mm
7130000001

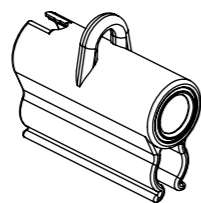

FSS rami prowadz ce prawe
7114301000

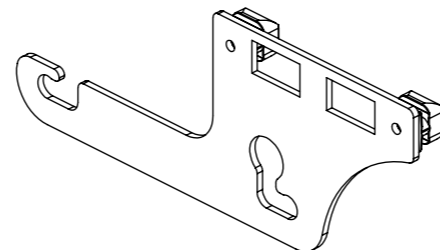

FSS rami prowadz ce lewe
7114401000

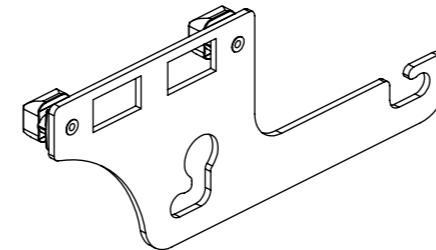

FSS uchwyt monta owy fix
7160001000

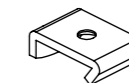

FSS tuleja
7103012000

